

AUDIOVOX®

OWNER'S MANUAL



VBP5000

**VIDEO IN A BAG SYSTEM WITH
5.6" LCD MONITOR VCP & DVD PLAYER**

A. INTRODUCTION

Thank you for selecting the VBP5000 "Video in a Bag" System. The system's main features include a 5.6" Liquid Crystal Display (LCD) Monitor Video Cassette Payer (VCP) and a DVD Player. The VBP5000 utilizes state of the art electronics and is designed for use in Vehicles, Hotels, the Office and Home. The "Video in a Bag" System is constructed to provide years of reliable, trouble-free service. The system is compact so that you can take it with you anywhere and is designed for quick and easy installation. The LCD monitor is detachable and can be utilized and stored separately from the main unit. Two additional monitors can be purchased and added to the system setup* allowing you to utilize three monitors at once (two external and one attached). The connection of the additional monitor is plug and play.

***NOTE:** The AC Adaptor will only support Two Monitors.

Please read the entire instruction manual supplied with this product prior to operation. The documentation will assist you in installing the system properly to obtain the best equipment performance. All documentation should be stored for later use.

SAFETY PRECAUTION

For safety reasons, when changing video media, it is recommended that the vehicle is not in motion, and that you do not allow children to unfasten seat-belts to change video media or make any adjustments to the system. Enjoy your entertainment system but always remember-safety of all passengers remains the number one priority.

IMPORTANT NOTICE

It is unlawful in most jurisdictions for a person to drive a motor vehicle which is equipped with a television viewer or screen that is located in the motor vehicle at any point forward of the back of the driver's seat, or that is visible, directly or indirectly, to the driver while operating the vehicle. In the interest of safety, this system should never be installed where it will be visible, directly or indirectly, by the operator of the motor vehicle.

B. CAUTIONS AND WARNINGS

The Monitor is best kept in the fully closed position when it is attached to the VCP/DVD Player and not in use. Before putting on headphones always adjust the volume setting to the lowest position. Do not apply pressure to the screen. Caution children to avoid touching or scratching the screen, as it may become dirty or damaged.

1. PLACEMENT

To prevent fire or electric shock, do not expose this appliance to rain or moisture. Do not place the set on an unstable cart, stand, bracket or table to prevent it from falling. Keep the unit away from strong magnets, heat sources, direct sunlight, excessive dust. If the unit is brought directly from a cold to a warm location, moisture may condense inside the unit. When you move it from a cold to a warm location, wait for about one hour before operating the unit, or remove the disc and leave the unit turned on until the moisture evaporates.

2. INSTALLATION

Ensure that the LCD Monitor, VCP, DVD Player, Bag and Pouch are installed in accordance with the instructions and illustrations provided in this manual. When the main unit is in the bag, ensure the inside Velcro Strap of the bag is fastened to prevent the unit from falling out of the bag (Refer to Figure 1). The "S" hooks and all straps must be fastened correctly to secure the system in the vehicle in the event of an accident. Operate the "Video in a Bag" System with the bag open to ensure proper ventilation of the VBP5000 system (Monitor/VCP/DVD Player). The system is intended to be mounted for rear seat viewing only. Do not use the system in the front seat while operating your vehicle.

3. POWER

This system **MUST** be powered from the type of switched (Accessory) power indicated on the marking label (i.e. not directly from the car battery). Power should be applied to the unit when the ignition key is in the Run and/or Accessory positions. To prevent battery discharge, disconnect the "Video in a Bag" System jack from the cigarette lighter socket when the unit is not in use. Use only the supplied power cable matching this set to avoid electric hazards. Always disconnect the power source first and then the jack from the system.

4. OBJECT AND LIQUID

Do not push objects of any kind into the system through openings; do not spill or spray liquid of any kind on or in the system (this may result in a fire or electric shock). Do not place anything heavy on the unit. To ensure proper ventilation and proper operation, never cover or block the slots and openings with a cloth or other material.

5. DISASSEMBLE

Do not attempt to disassemble the cabinet. There is a risk of electric shock and/or exposure to Laser Radiation. Contact qualified service personnel if your system is in need of repair.

6. CLEANING UNIT

When cleaning, make sure the system is unplugged from the power source. Do not use any solvents or cleaning materials (liquid, abrasive or aerosol) when cleaning the Video Monitor doing so may scratch the screen. Use only a lightly dampened lint free cloth to wipe the screen if it is dirty.

7. DISC

Do not use irregularly shaped discs such as heart or star-shaped discs as they may cause the unit to malfunction.

Do not stick paper, tape or glue on the disc. Do not expose the disc

to direct sunlight or heat sources such as hot air ducts. Do not touch the surface of disc. Handle the disc by its edge. Clean the disc by wiping the disc from the center out with a cleaning cloth. Remove the disc from the unit and store it in its case after playing. Some playback operations of discs may be intentionally fixed by software producers. Since this unit plays discs according to the disc contents the software producers designed, some playback features may not be available. Also refer to the instructions supplied with the discs.

8. VIDEO CASSETTE

Do not force a cassette into the compartment when the power cord is unplugged. An inverted cassette cannot be inserted. After playing a videocassette, remove it from the player. Store videocassettes in the sleeves or cases.

9. CLEANING VIDEO HEAD

To prevent video head clogging, use only good quality VHS tapes and discard worn tapes. If the heads become dirty over a period of time during normal operation of the VCP, the picture will be snowy and the auto-tracking will not adjust the picture correctly. We recommend using cleaning cartridges sparingly to restore normal picture.

C. CONTENTS

1. 1 x Detachable Monitor & VCP & DVD Player Combo
2. 1 x DIN Cable
3. 1 x AC to DC Adapter
4. 1 x Cigarette Lighter Adapter
5. 1 x Remote Control with 2 AAA Batteries
6. 1 x Pouch
7. 1 x Mounting Bag with 4 Straps
8. 1 x Storage Bag
9. 1 x Instruction Manual

D. INDOOR PLACEMENT (IN A HOTEL, OFFICE, HOME, ETC)

To remove the VBP5000 from the protective mounting/storage bag, place the open end of the unit face down on a flat surface. Unfasten the Velcro Strap and pull it through the loop. Detach all cables and slide the bag upward and off of the unit. Refer to Figure 1.

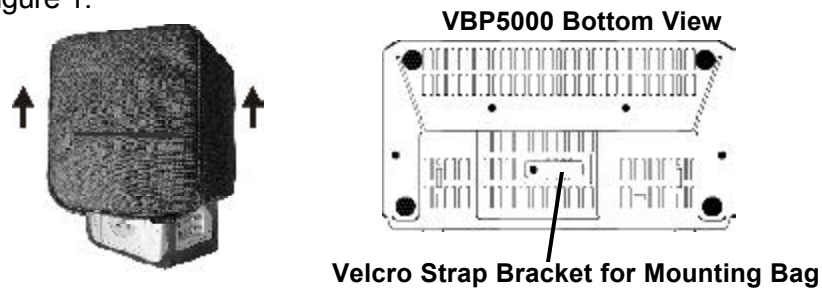

Figure 1

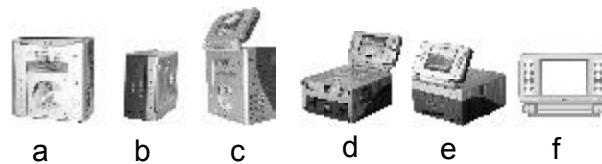

Figure 2

Refer to the Figure 2. There are different ways to place the main unit, monitor or combo on a table or other level surface. You can detach* the monitor from the main unit by depressing the button below the screen with one hand and removing the monitor with the other hand. You can insert the monitor into the slot on the main unit with the screen facing either front or back. Adjust the screen for the desired viewing angle. The placement can be done with or without the unit inside its mounting bag and pouch.

***NOTE:** During the Removal and Reinstallation of the Video Monitor, rotate the monitor and the monitor's hinged base so that they are aligned in a straight line. The Video Monitor is inserted into the slot on the main unit at a 45°.



Figure 3

E. IN-CAR INSTALLATION

NOTE: When used in a vehicle, always keep the VBP5000 fastened in the mounting bag.

1. BETWEEN TWO SEATS

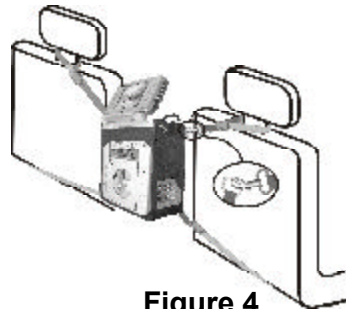

Figure 4

- a. Refer to Figure 4. Take one of the supplied straps from the storage bag, and connect the latch to the upper side metal ring on the left side of the mounting bag. Attach the "S" hook to the same ring after looping the strap around the headrest of the driver's seat. Repeat this process for the right side (Passenger Seat).
- b. Take another strap and connect the latch to lower metal ring on the left side of the bag. Attach the "S" hook to the same ring after looping the strap around the driver's seat rail. Repeat this process for the right side. In some vehicles, it may be necessary to attach the "S" connector to the rail directly, as it may not be long enough to reach back to the ring.
- c. Adjust the straps tightly so that the mounting bag is secured.
- d. Swing the monitor upwards and adjust the screen for the desired viewing angle.

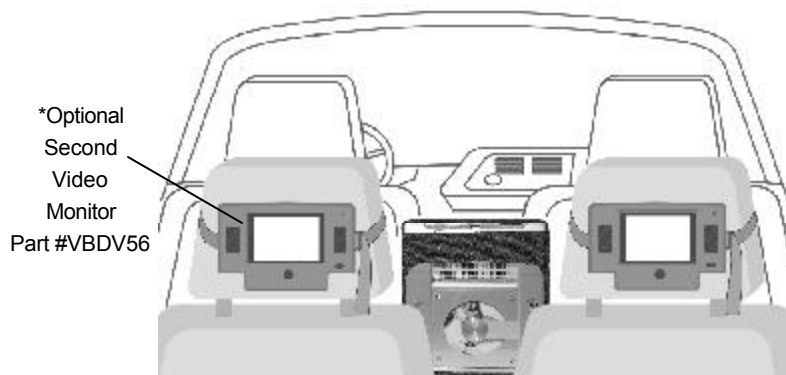

Figure 5

- e. Refer to Figure 5. The monitor can be detached from the system by depressing the button below the screen with one hand and removing the monitor with the other (Refer to Figure 3). Slide the monitor into the monitor pouch, feed the bottom flap of the pouch into the long slot of the monitor, and attach the Velcro

- strap to fasten the monitor in the pouch. Then loop the strap of the pouch around the headrest, and pull the loose end of the strap while holding the buckle until the pouch is tightly secured.
- f. If a second video monitor (optional) is used, remove the additional monitor and pouch from the storage bag, making sure to feed the bottom piece of the pouch into the long slot of the monitor and attach the Velcro strap to fasten the monitor in the pouch. Then loop the strap of the pouch around the headrest and pull the end of the strap while holding the buckle until the pouch is tightly secured.
 - g. Insert one end of the DIN cable into the MONITOR PORT on the side of the detached monitor, and insert the other end into the MONITOR PORT on the side of the main unit.

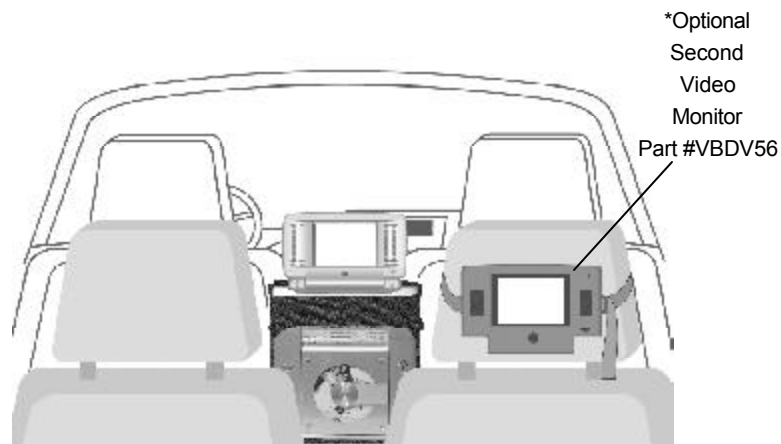

Figure 6

- h. Refer to Figure 6. You can contact an AUDIOVOX retailer for additional monitor(s) Part #VBDV56, and insert it into the slot of the main unit, or fasten it in the pouch onto the headrest, or just hold it in your hand and connect it to the main unit with the DIN cable.

2. ON THE SEAT BACK (Refer to Figure 8)



Figure 7

- a. Hang the bag onto the seat back by looping the shoulder strap of the bag around the headrest of the seat.
- b. Take one of the supplied straps from the storage bag, and connect the latch to the lower metal ring on the left side of the mounting bag. Attach the "S" hook to the same ring after looping the strap around the seat rail. Repeat this process for the right side. In some vehicles, it may be necessary to attach the "S" connector to the rail directly, as it may not be long enough to reach back to the ring.
- c. Adjust the straps tightly so that the mounting bag is secured.
- d. Swing the monitor upwards and adjust the screen for the desired viewing angle.

3. On the Back Seat

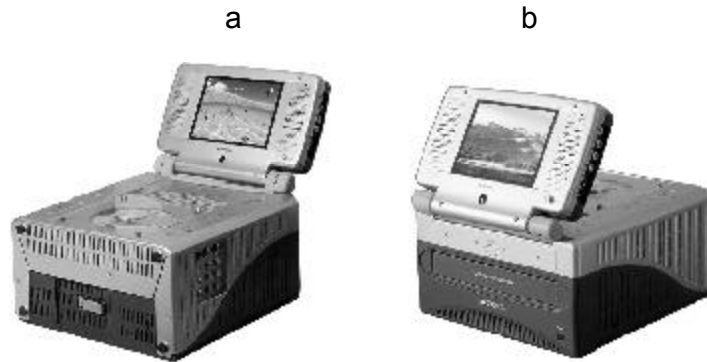

Figure 8

- a. The Monitor can be inserted into the slot with the screen facing either front (refer to Figure 8a) or rear (refer to Figure 8b). Carefully place the system with the DVD facing up on the back seat. Guide the vehicles safety belt through the short strap sewn on the bottom of the mounting bag. Then secure and adjust the safety belt so that the unit is not free to move around. Finally uncover the attached monitor and adjust the screen for a desired viewing angle.

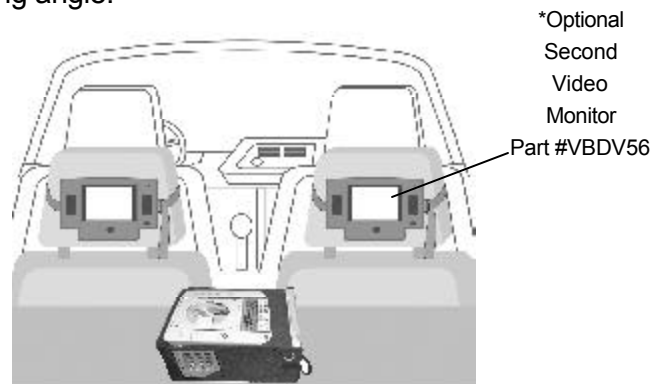

Figure 9

- b. Refer to Figure 9. The monitor can be detached from the system by depressing the button below the screen with one hand and removing the monitor with the other (Refer to Figure 3). Slide the monitor into the monitor pouch, feed the bottom piece of the pouch into the long slot of the monitor, and attach the Velcro strap to fasten the monitor in the pouch. Then loop the strap of the pouch around the headrest, and pull the end of the strap while holding the buckle until the pouch is tightly secured.
- c. If a second video monitor (optional) is used, remove the additional monitor and pouch from the storage bag, making sure to feed the bottom piece of the pouch into the long slot of the monitor and attach the Velcro strap to fasten the monitor in the pouch. Then loop the strap of the pouch around the headrest and pull the end of the strap while holding the buckle until the pouch is tightly secured.
- d. Insert one end of the DIN cable into the MONITOR PORT on the side of the detached monitor, and insert the other end into the MONITOR PORT on the side of the main unit. Repeat this process if an optional second monitor is used (2nd DIN cable is supplied with the optional monitor). Contact an Audiovox's retailer for an additional monitor, and insert it into the slot of the main unit, or fasten it in the pouch onto the headrest, or just hold it in your hand and connect it to the main unit with the DIN cable.

F. POWER SUPPLY

1. *Powering the system indoors* (Refer to Figure 10)



Figure 10

Take the AC to DC adapter from the storage bag. Plug one end of the AC to DC adapter into the DC 12V jack on the side of the main unit, then plug the other end into the 110V AC power receptacle.

2. *POWERING THE SYSTEM IN THE VEHICLE* (Refer to Figure 11)

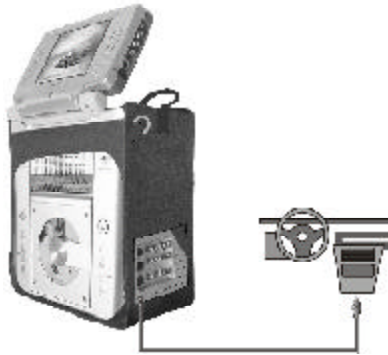

Figure 11

Take the cigarette lighter adapter from the storage bag. Plug one end into the DC 12V jack on the side of the main unit, then plug the other end into the cigarette lighter socket*.

***NOTE:** Always disconnect the VBP5000 when not in use.

3. POWERING THE DETACHED MONITOR INDOORS (Refer to Figure 12)

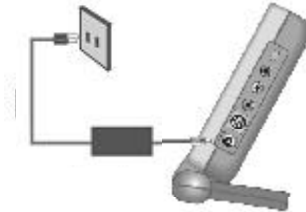

Figure 12

The monitor can be detached from the system by depressing the button below the screen with one hand and removing the video monitor* with the other hand.

***NOTE:** During the Removal and Reinstallation of the Video Monitor, rotate the monitor and the monitor's hinged base so that they are aligned in a straight line. The Video Monitor is inserted into the slot on the main unit at a 45° (refer to Figure 3).

Take the AC to DC adapter from the storage, plug one end into the DC 12V jack on the side of the monitor, then plug the other end into the 110V AC power receptacle.

4. POWERING THE DETACHED MONITOR IN THE VEHICLE (Refer to Figure 13)

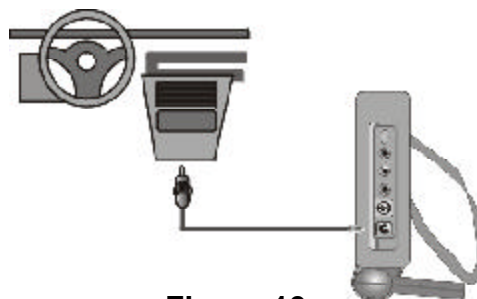

Figure 13

Take the cigarette lighter adapter from the storage bag, plug one end into the DC 12V jack on the side of the monitor, then plug the other end into the cigarette lighter socket.

NOTE: When the monitor is combined with the main unit DC 12V power will be supplied from the main unit to the monitor, so there is no need for another power source to be connected to the DC 12V jack on the side of the monitor.

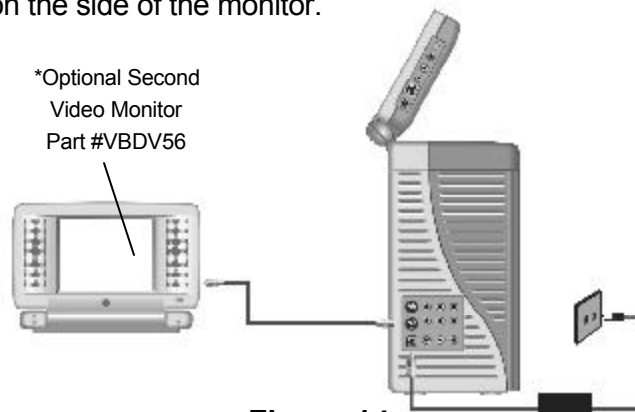

Figure 14

5. POWERING THE SYSTEM WITH MULTIPLE MONITORS

(Refer to Figure 14)

1) When the monitor is detached from the main unit, you can connect the PORT on the side of the monitor to either MONITOR 1 port or MONITOR 2 port on the side of the main unit with the supplied DIN cable. When the monitor is connected to the main unit with the DIN cable, DC 12V power, Audio/Video and IR signals will all be supplied through the DIN cable to the connected monitor. So there is no need for another power source to be connected to the DC 12V jack on the right side of the detached monitor. In this situation, the AC to DC adapter can drive only two monitors either combined with the main unit or connected to the main unit with the DIN cable.

2) Refer to Figure 15. In the vehicle, the cigarette lighter adapter can drive up to 3 monitors combined with the main unit and connected to the main unit with the DIN cable.

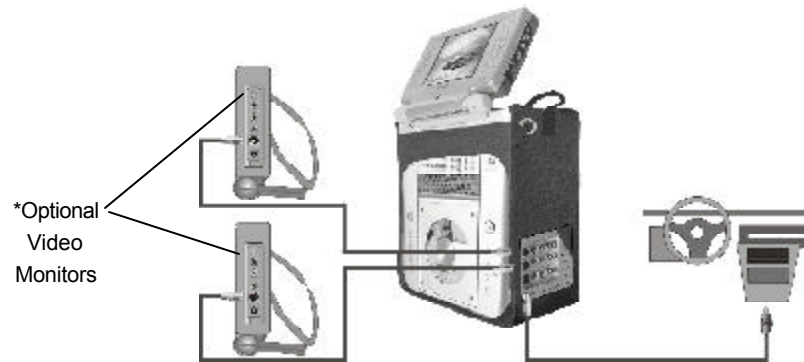

Figure 15

G. CONTROLS, INDICATORS, AND CONNECTORS

1. UNIT VIEW (Refer to Figure 16)

MONITOR RIGHT SIDE

- 1) Brightness UP/DOWN Thumbwheel
- 2) Volume UP/DOWN Thumbwheel
- 3) Headphone Input # 2
- 4) Headphone Input # 1

MAIN UNIT

- 5) REMOTE CONTROL SENSOR
- 6) MAIN POWER
- 7) VCP STOP/EJECT Button
- 8) VCP REWIND Button
- 9) VCP PLAY Button
- 10) VCP FAST FORWARD Button
- 11) DVD/AV and VCP SELECT Switch
- 12) DVD OPEN Button
- 13) DVD STOP Button
- 14) DVD PREVIOUS Button
- 15) DVD PLAY Button
- 16) DVD NEXT Button

MONITOR LEFT SIDE

- 17) POWER ON/OFF BUTTON (Monitor)
- 18) RIGHT AUDIO IN (Monitor)
- 19) LEFT AUDIO IN (Monitor)
- 20) VIDEO IN (Monitor)
- 21) MONITOR JACK (Input)
- 22) DC 12V INPUT (Monitor)

MAIN UNIT BOTTOM

- 23) DVD/AV OUTPUT
- 24) MONITOR PORT #1 (Output)
- 25) VCP AV OUTPUT
- 26) MONITOR PORT #2 (Output)
- 27) DC 12V INPUT
- 28) AV INPUT

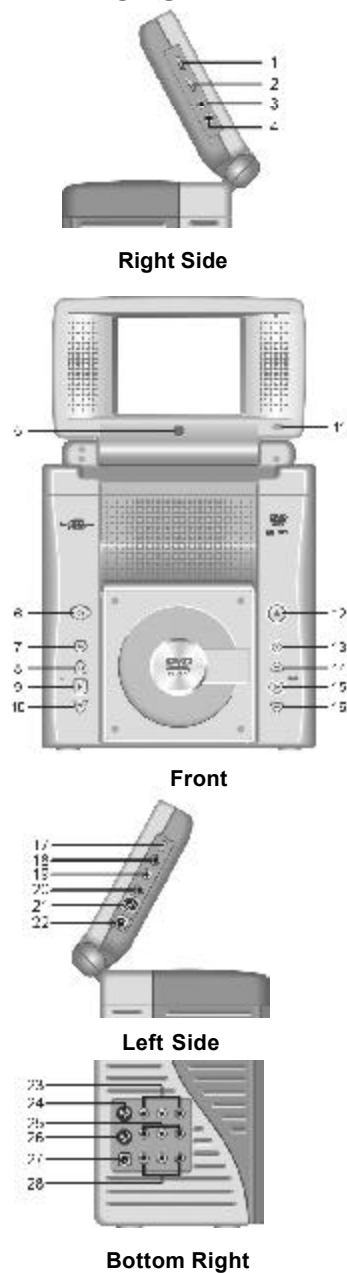

Figure 16

2. REMOTE CONTROL VIEW (Refer to Figure 17)

- 1) POWER Button
- 2) DISPLAY Button
- 3) DVD ANGLE Button
- 4) DVD SUBTITLE Button
- 5) DVD AUDIO Button
- 6) DVD ZOOM Button
- 7) DVD UP/DOWN/LEFT/RIGHT/ENTER Buttons
- 8) DVD MENU Button
- 9) DVD Return Button
- 10) DVD A-B Button
- 11) DVD NEXT Button
- 12) DVD PREVIOUS Button
- 13) DVD REVERSE Button
- 14) DVD FORWARD Button
- 15) VCP EJECT Button *
- 16) VCP POWER Button
- 17) VCP PAUSE Button
- 18) VCP STOP Button
- 19) DVD NUMBER Button
- 20) DVD SETUP Button
- 21) DVD REPEAT Button
- 22) DVD PAUSE Button
- 23) DVD PLAY Button
- 24) DVD STOP Button
- 25) DVD SLOW Button
- 26) VCP PLAY Button
- 27) VCP FAST FORWARD Button
- 28) VCP REWIND Button

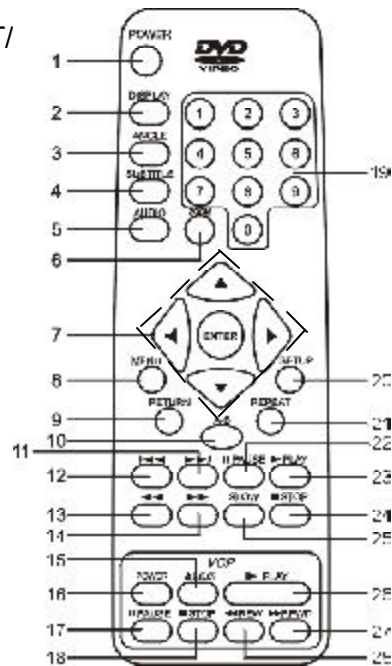

Figure 17

***NOTE:** To Eject a tape with the Remote Control, you must press the Stop button first.

H. PLAYING A DVD

After connecting power to the unit, momentarily press the 'Power' button on the Main Unit, then press the 'Power' button on the side of the Monitor. Press the 'OPEN' button on the Main unit to open the DVD Player, insert a disc and close the DVD Player. The system will start playing automatically. If the 'POWER' button is pressed 'ON' when there is already a disc in the unit, the system will automatically start playback of the disc.

1. BASIC DVD OPERATION

POWER	Turns the Main Unit ON and OFF
DVD/AUX/VCP ...	Selects either DVD, AUX or VCP Playback
OPEN	Opens the DVD Cover
PLAY	Starts Playback
SLOW	Plays DVD at 1/2, 1/4, or 1/8 Times the Normal Playback Speed
PAUSE	Still Picture
STOP	(1 time) Stops Playback and will resume at the Present Playback Point when the PLAY button is pressed again (2 times) Stops Playback and returns to the beginning
NEXT	Advances to the Next Chapter, Track or Scene during playback
PREVIOUS	Goes back to the preceding chapter, track or scene during play back
FORWARD	Scans Forward at 2, 4, 6, or 8 times Normal Speed
REVERSE	Scan Backward at 2, 4, 6, or 8 times Normal Speed
UP/DOWN/	
LEFT/RIGHT	Used for Menu Navigation
ENTER	Execute an Item or Setting
NUMBERS	Select an Item or Setting
RETURN	Return to the previous selection
MENU	Display the Root Menu of the disc
REPEAT	Repeat Playback of a Title or Chapter
A-B	Repeat a specific portion from point A to point B of the disc
DISPLAY	Display information (Title, Chapter, Track, Time, etc.)
ANGLE	Change the Angles on the scene (if available)
SUBTITLE	Selects the Subtitle Language and turns it ON/OFF
AUDIO	Select the Audio Language
ZOOM	Enlarge an Image to 1.5, 2, or 4 times the original
SETUP	Display the Setup Menu to select and set items and exit the setup menu

2. MENU

A DVD is divided into sections called titles and chapters. When you play a DVD, a root menu of the disc will appear on the screen of your TV or Monitor. The contents of the menu vary from disc to disc. Press MENU during playing to display the menu, and press ENTER or PLAY to start playing. Some DVDs only allow you to select disc playback options using the DVD menu.

3. DISPLAY (Display contents vary from disc to disc.)

1) PLAYING TIME AND REMAINING TIME

- a. During playback press 'DISPLAY' to display the current Title Number (1), the total Number of Titles (2), the current Chapter Number (3), the total Number of Chapters (4), and the Playing Time for the title (5). The heading will disappear automatically after 3 seconds if no buttons are pressed.

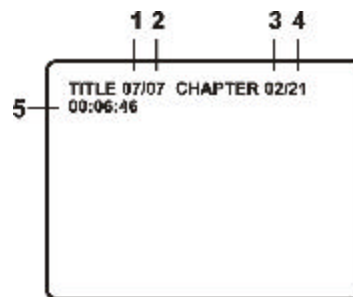

Title, Chapter Number, and Time Screen Display

- b. Press 'DISPLAY' again to display the Remaining Time of the title. The heading will disappear automatically in about 3 seconds.

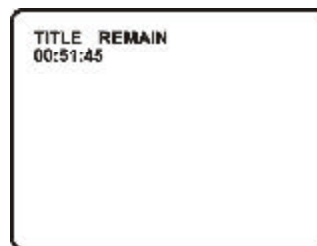

Title Remaining Time Screen Display

- c. Press 'DISPLAY' the 3rd time to display the Elapsed Time for the chapter. The heading will disappear automatically in about 3 seconds.

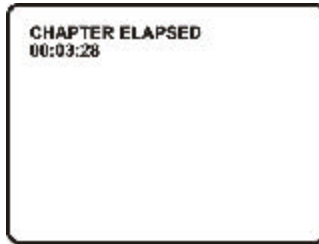

Chapter Elapsed Time Screen Display

- d. Press 'DISPLAY' the 4th time to display the Remaining Time for the chapter. The heading will disappear automatically after 3 seconds. Press 'DISPLAY' a 5th time to exit.

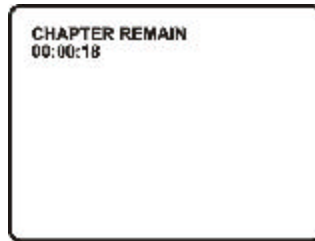

Chapter Remaining Time Screen Display

2) ANGLE

During playback of a disc, press 'ANGLE' to display the available angles for discs containing multi-angles*, with the current angle number (1) and the total number of angles (2) displaying. Press 'ANGLE' to select another angle, then press again to exit and return to the normal viewing angle. The angle display will disappear automatically if the 'ANGLE' button is not pressed again within 3 seconds.

***NOTE:** Not all discs contain this feature

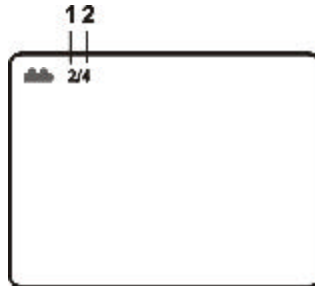

Angle Screen Display

3) SUBTITLE

During disc playback press 'SUBTITLE' to select the subtitle language you desire, with the current Subtitle Language Number (1) and the total Number of Subtitle Languages (2) displayed. If there are multiple languages press 'SUBTITLE' again to select another subtitle language. To turn subtitles OFF, press the 'SUBTITLE' button until 'SUBTITLE OFF' is displayed. The Subtitle display will disappear automatically if the 'SUBTITLE' button is not pressed again within 3 seconds.

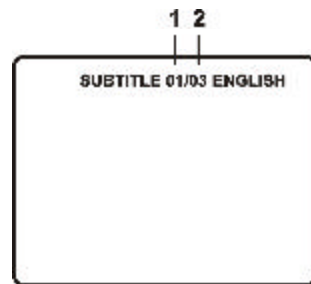

Subtitle Screen Display

4) AUDIO

During playback press 'AUDIO' to select the audio language you desire, with the current Audio Channel Number (1) and the total number of Audio Channels (2) displayed. Press AUDIO again to select another audio language. The audio display will disappear automatically if the 'AUDIO' button is not pressed again for 3 seconds.

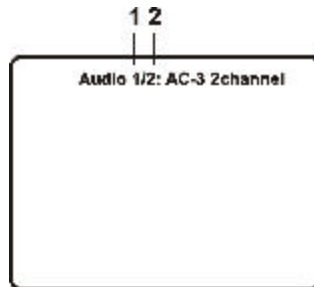

Audio Language Screen Display

5) ZOOM

During playback press 'ZOOM' to enlarge the picture by 1.5, 2, or 4X with the current zoom multiple (1) displaying. Press 'UP/DOWN/LEFT/RIGHT' to move the picture. Press 'ZOOM' again to select another zoom multiple or until ZOOM OFF is displayed and the picture will return to normal size. The zoom display will disappear automatically if the 'ZOOM' button is not pressed within 3 seconds.

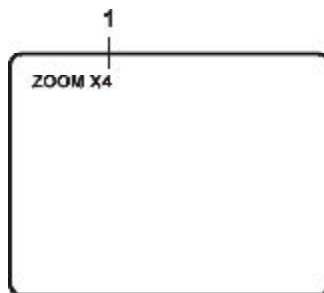

ZOOM Screen Display

6) A-B REPEAT

- a. During playback press 'A-B' to set the Starting Point A.



A - B Repeat Starting Point Screen Display

- b. Press 'A-B' to set the Ending Point B and the player will repeatedly play the part between Point A and Point B.



A - B Repeat Ending Point Screen Display

- c. Press 'A-B' a 3rd time to Cancel A-B Repeat. Normal playback will resume from Point A.

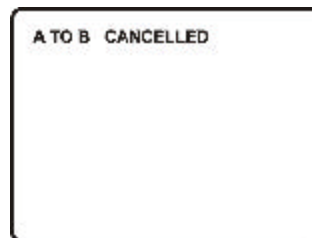

A-B Repeat Cancelled Screen Display

7) REPEAT

- a. During playback press 'REPEAT' once to repeatedly play the current chapter.

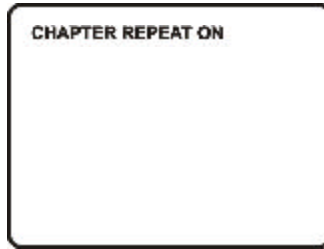

Chapter Repeat ON Screen Display

- b. During playback press 'REPEAT' again to repeatedly play the current title.

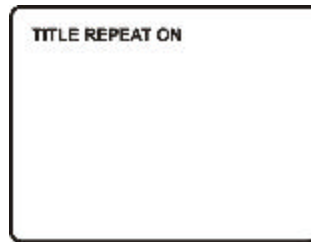

Title Repeat ON Screen Display

- c. During playback press 'REPEAT' a 3rd time to cancel the repeat playback function and resume normal play back. The repeat display will disappear automatically if the 'REPEAT' button is not pressed again for 3 seconds.

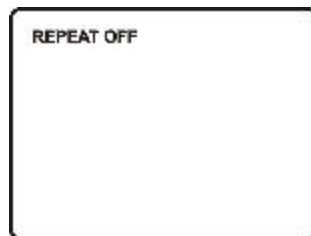

Repeat OFF Screen Display

4. PLAYING AUDIO CDS

When playing an audio CD, the DISPLAY Banner appears automatically. It displays the current track and the amount of the time for that track playing, the total amount of time on the disc and the current time running on the disc. Press the DISPLAY button on the remote to display the DISPLAY Banner. The options below show you what happens when you press the DISPLAY button.

- a. During playback press 'DISPLAY' once and *SINGLE ELAPSED* will appear along with the current track playing and the time of that track.

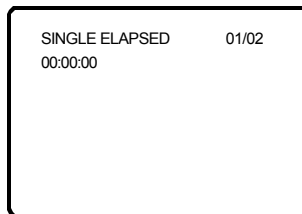

SINGLE ELAPSED Screen Display

- b. Press 'DISPLAY' 2 times and *SINGLE REMAIN* appears along with the current track playing the and the amount of time left.

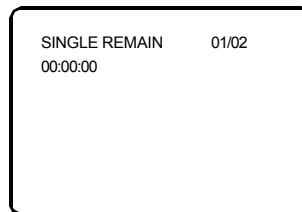

SINGLE REMAIN Screen Display

- c. Press 'DISPLAY' three times and *TOTAL ELAPSED* appears along with the current track playing the total time playing on the CD.

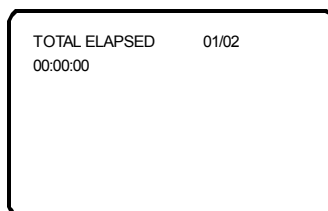

TOTAL ELAPSED Screen Display

- d. Press 'DISPLAY' four times and *TOTAL REMAIN* appears along with the current track playing and the amount of time left on the CD.

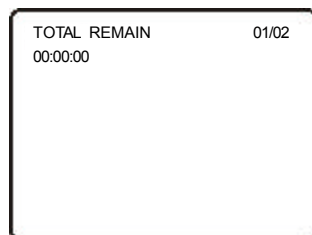

TOTAL REMAIN Screen Display

- e. Press 'DISPLAY' a fifth times and "OFF" will appear momentarily then disappear. CD Time Information will not be displayed.

1) USING THE REPEAT FEATURE

The default mode for the Repeat feature is OFF. Pressing REPEAT consecutively changes the repeat options:

- *REP-ONE*- repeats the track that is playing.
- *REP-ALL*- repeats the disc that is playing.
- *REPEAT OFF*

As you toggle through the options, the repeat option changes. The selected repeat option loops repeatedly until you turn it off.

5. PLAYING MP3 DISCS

MP3 is a format for storing digital audio. An audio CD-quality song can be compressed into the MP3 format with very little loss of quality, while taking up much less space. CD-R discs that have been encoded in MP3 format can be played on your DVD player.

SELECTING FOLDERS AND SONGS

When an MP3 disc is inserted in the player, the SMART NAV screen will appear automatically. The SMART NAV screen is used to change folders and songs as well as display Disc TIME and TITLE Information. Songs are played in order they were saved on to the disc.

1. Once the Disc is loaded and is playing, press 'STOP' then press either the UP or DOWN arrow buttons on the Remote Control to navigate through the folder list on the right side of the SMART NAV screen.
2. Once the folder you want is highlighted, press 'ENTER' (the folder list shifts to the left side of the screen and the songs in the folder appear on the right).

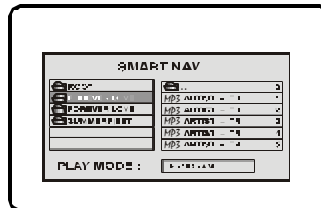

SMART NAV Screen Display

3. Press the UP or DOWN Arrow buttons on the Remote Control to navigate through the song list and highlight the song you want. Press 'ENTER' to begin playback of that song.

SKIPPING SONGS

Use the Next (▶▶) button on the remote control to move to the next song. Use the Previous (◀◀) button to move to the beginning of the currently playing song. Press the button again to move to the previous song.

3) *USING THE REPEAT FEATURE*

The default mode for the Repeat feature is OFF. Pressing REPEAT consecutively changes the repeat options:

- *REP-ONE*- repeats the songs that is playing.
- *FOLDER REP*- repeats the folder that is playing.
- *FOLDER*- turns off repeat and returns to regular play mode.

4) *SELECTING A PLAY MODE*

You can choose what order the songs will play on a disc temporarily. The FOLDER play mode is the default. To access the play mode options, press STOP if the disc is playing. Press the right arrow button until the PLAY MODE option is highlighted. Use the up or down arrow to choose an option. The play mode options are:

- *SINGLE*: Play a selected song.
- *REP_ONE*: Repeats the song that is playing.
- *FOLDER*: Plays the folder in the order the songs were recorded.
- *FOLDER REP*: Repeats the folder that is playing.
- *DISC SCAN*: Plays the first ten seconds of each song on the disc. When the desired track is heard, press play to begin play of the track.
- *DISC*: Plays the entire disc.
- *DISC REP*: Repeats playback of the entire disc.
- *RANDOM*: Plays the songs on the entire disc in random order.
- *SHUFFLE ON*: Plays the songs in random order (from within the selected folder)
- *PROGRAM PO*: Plays the songs on the disc in the order you have programmed (you must create a playlist to set the order you want the tracks on the disc to play). When you are creating a playlist, this option changes to PROGRAM.

5) PROGRAM PLAY

To use the program play option, you must create a playlist of songs in the order you want them to play.

Note: Once you begin adding songs from a folder to create your play list, you cannot add songs from a different folder.

- a) Choose the PROG-PO option from the PLAY MODE then press Enter to change the option to PROGRAM.
- b) Add songs to the program list by highlighting the song you want to program and pressing ENTER once the song is highlighted. The song you have chosen and the number of songs you have chosen appear at the top of the screen. For example, if you choose the number five song within the folder and it is the first song you have chosen, PROGRAM P01:05 appears.
- c) You can continue to add songs to the list from within the same folder by using the up or down arrow button and then pressing ENTER to add it to the list.
- d) When you are done creating the list, press STOP to end the programming, PROG END will be displayed. Then press PLAY to begin the program play mode.

6) DELETING THE PLAYLIST

To delete the entire playlist, press STOP while the disc is playing and change to another play mode.

7) DISPLAYING THE TIME ELAPSED AND TIME REMAINING

Press the 'DISPLAY' button on the remote to display disc information. The options below show you what happens when you press the 'DISPLAY' button.

- a) Press 'DISPLAY' once, and "TIME ELAPSED" will appear along with the amount of time the song has been playing. "TIME ELAPSED" and the amount of actual time the disc has been playing, will be displayed on-screen until you press DISPLAY again.

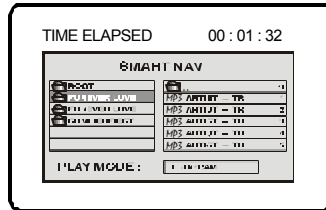

TIME ELAPSED Screen Display

- b) Press 'DISPLAY' a Second time and *TIME REMAIN* will appear along with the amount of time left in the song that is playing. *TIME REMAIN* and the amount of time remaining will be displayed on-screen until you press DISPLAY again.

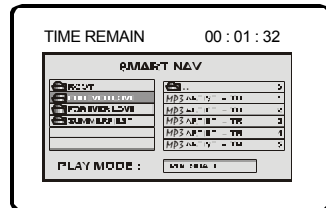

TIME REMAIN Screen Display

- c) Press 'DISPLAY' a Third time and "OFF" will appear momentarily then disappear. CD Time Information will not be displayed.

6. SETUP (The contents vary from disc to disc.)

Press 'SETUP' to display the Main screen of the SETUP Menu on the screen. Press 'SETUP' again to exit the SETUP Menu and the unit will resume its last playback or stop mode.

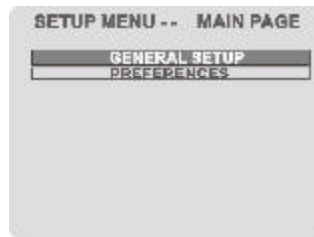

Main SETUP Menu Screen

1) Select 'GENERAL SETUP' using the UP/DOWN buttons, then press 'ENTER' to enter the GENERAL Setup screen.

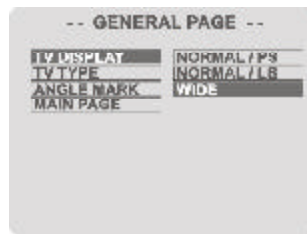

General SETUP Menu Screen

a. Select TV DISPLAY using UP/DOWN, and then press RIGHT to enter the submenu. Select the TV display mode on the screen using UP/DOWN, and press ENTER to confirm the setting. Press LEFT to return.

* NORMAL/PS: When the player is connected to a normal TV, and a wide picture is shown on the full screen.

* NORMAL/LB: When the player is connected to a normal TV, and a wide picture is shown on the screen, with black strip at both top and bottom of the screen.

* WIDE: When the player is connected to a wide screen TV, a wide picture is shown on the full screen.

- b. Select 'ANGLE MARK' using UP/DOWN, and then press the RIGHT button to enter the submenu. Choose Angle Mark on or off displayed on the screen using the UP/DOWN and then press ENTER to confirm the setting. Press the LEFT button to return.

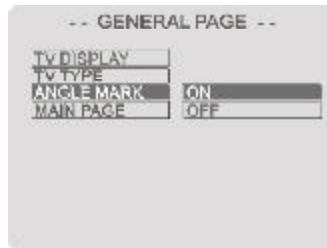

ANGLE MARK Screen Display

* ON: The screen will show angle mark. (If angle option is available)

* OFF: The screen will not display the Angle Mark.

- c. Select 'MAIN PAGE' using UP/DOWN, and then press ENTER to return to the main page.

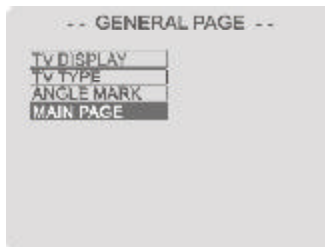

MAIN PAGE Screen Display

- 2) When there's no disc inside the player, select 'PREFERENCES' using UP/DOWN, and then press 'ENTER' to enter the preferences page.

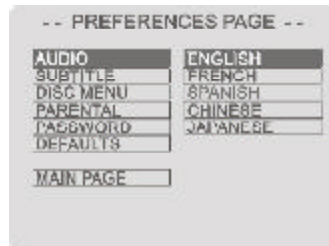

AUDIO Preference Screen Display

- Select 'AUDIO' using UP/DOWN, and then press 'RIGHT' to enter the submenu. Select the audio language you desire using UP/DOWN, and then press 'ENTER' to confirm the setting. Press LEFT to return.
- Select 'SUBTITLE' using UP/DOWN, and then press RIGHT to enter the submenu. Select the desired subtitle language or SUBTITLE OFF using UP/DOWN, and then press 'ENTER' to confirm the setting. Press 'LEFT' to return.

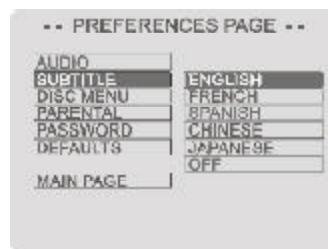

SUBTITLE Preference Screen Display

- c. Select 'DISC MENU' using UP/DOWN, and then press 'RIGHT' to enter the submenu. Select the Disc Menu Language you desire using UP/DOWN, then press 'ENTER' to confirm the setting. Press 'LEFT' to return.

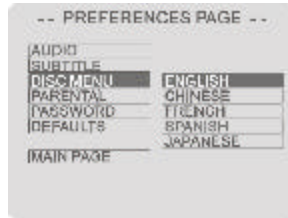

DISC MENU Preference Screen Display

Note: Language and subtitle selection is only available for discs that are recorded in the above listed languages. If not, the player will play and display on the screen the original recorded language contained in the disc.

- d. Select 'PARENTAL' using UP/DOWN, and then press RIGHT to enter the submenu.

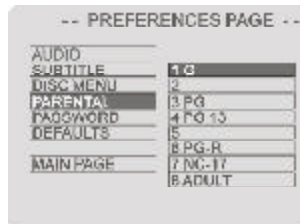

PARENTAL Preference Screen Display

Select the parental level you desired using UP/DOWN for discs with lock-out function or multiple rating levels. It's listed from the lowest level (1 Child) to the highest level (8 Adult). Press 'ENTER' to enter the Password Verify Page.



PASSWORD VERIFY Input Screen Display

Enter a 4 digit password, then press 'ENTER' to confirm the parental level setting.

NOTE: For 1st time use, the default password 3308.

- e. Select 'PASSWORD' using UP/DOWN, and then press RIGHT to enter the submenu.

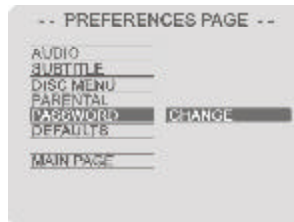

PASSWORD CHANGE Screen Display

Press 'ENTER' to enter the Password Change Page. Input the Old Password or the Default Password, the New Password, and the Confirmed New Password. Press 'ENTER' to confirm the change.



PASSWORD CHANGE PAGE Screen Display

NOTE: The Default Password is **3308**. This password is always effective even after you have selected your own password and changed it. To avoid others from using the default password to set the parental level and change the password, you can record this default password in another area and delete it from this manual. Some discs can be limited depending on the age of users while some discs can not.

f. Select 'DEFAULTS' using UP/DOWN, and then press RIGHT to enter the submenu. Press ENTER to make the setting return to the factory-set mode.

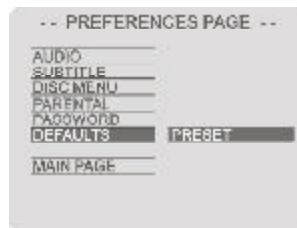

DEFAULT PRESET Screen Display

g. Select 'MAIN PAGE' using UP/DOWN, and then press ENTER to return to the main page. Press SETUP to exit the MAIN PAGE

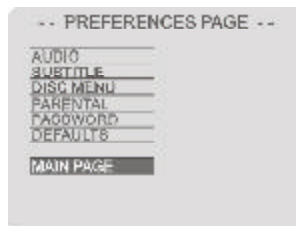

PREFERENCE MAIN Page Screen Display

I. BASIC VIDEO CASSETTE OPERATION

Power	Turn the unit ON/OFF
DVD/AUX/VCP	Choose the VCP mode
Play	To playback tape
Stop/Eject	To stop tape (press once), to eject tape (press twice)
Rewind	<p>a. Press it once in the playback mode, the VCP enters the reverse picture search mode and the tape will rewind rapidly with Video, the rewind indicator lamp will blink. Press it once more, and the tape will rewind scan at a high speed with the lamp blinking more quickly.</p> <p>b. Press it in the stop mode, the tape will rewind at a very high speed without any picture or sound.</p>
Forward (Fast)	<p>a. Press it once in the playback mode, the VCP enters the forward picture search mode and the tape advances rapidly with video, the fast forward indicator lamp will blink. Press it once more, and the tape will advance at a high speed with the lamp blinking more quickly.</p> <p>b. Press it in the stop mode, the tape will advance at a very high speed without picture or sound.</p>

J. PLAYING A VIDEO GAME (Refer to Figure 18)

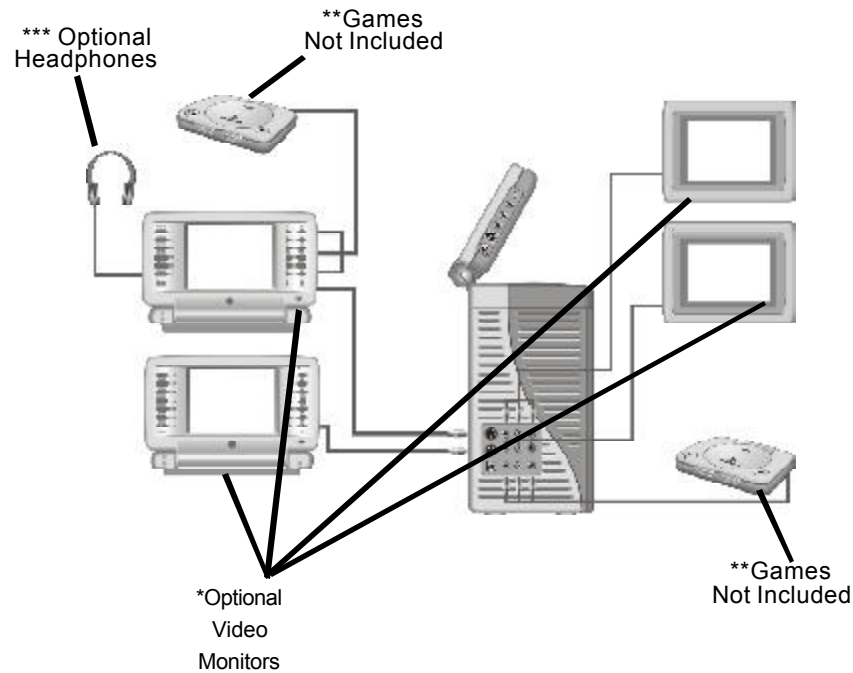

Figure 18

1. Plug the video output from your game system into the yellow video jack and the Audio L and Audio R into the applicable jacks on the side of the main unit, which takes priority over the built-in DVD player. Adjust the volume control and the brightness control on the monitor for individual preference.
2. Plug the video output from your game system into the yellow VIDEO jack and the AUDIO L and AUDIO R into the applicable jacks on the side of the monitor, which takes priority over both AV input into the main unit and the built-in DVD player. Adjust the volume control and the brightness control on the monitor for individual preference.

K. WIRED HEADPHONES (Refer to Figure 18)

Optional wired headphones may be used with the "Video In a Bag" System. Simply plug in the headset to either HEADPHONE 1 jack or HEADPHONE 2 jack on the left side of the monitor.

Note: Using HEADPHONE 1 jack will disconnect the internal speakers.

L. SUPPORT EXTERNAL MONITORS

1. Using MONITOR PORT (Refer to Figure 18 & 19)

Besides the monitor combined with the main unit, this system can drive up to 2 additional monitors (Please contact an Audiovox dealer for the additional monitors part # VBDV56) by using the cigarette lighter adapter in the vehicle. (**NOTE:** The AC to DC adapter can drive only 1 main unit and 2 monitors, either combined or detached). Connect the PORT on the additional monitor to either MONITOR 1 port or MONITOR 2 port on the left side of the main unit with the supplied DIN cable. After plugging in the main unit, DC 12V power, Audio/Video and IR signals will all be supplied through DIN cable to the additional monitor.

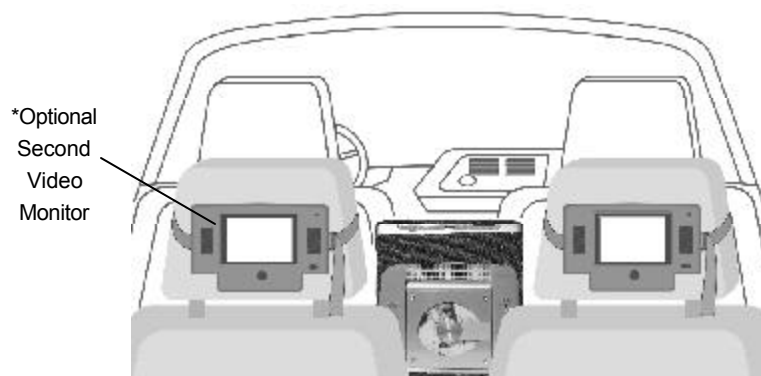

Figure 19

2. Using VIDEO, AUDIO L, AUDIO R outputs for connection to any monitor

(Refer to Figure 18)

Match the color-coded plugs to the appropriate DVD OUT jacks or VCP OUT jacks on the side of the main unit: Yellow (VIDEO) to Yellow, White (AUDIO L) to White, and Red (AUDIO R) to Red.

M. SPECIFICATION

Color system: NTSC

Screen size: 5.6"

Disc format: DVD/CD/MP3

DVD video format: Horizontal 720 pixel, vertical 480 pixel (NTSC)

Frequency response: DVD (PCM 96 kHz/24 bits): 20 Hz to 44 kHz

DVD (PCM 48 kHz): 20 Hz to 22 kHz

CD: 20 Hz to 20 kHz

Tape Width: 12.7mm

Tape Speed SP: 33.35 mm/s

Tape Playback Time: 180 minutes with T-180 set to the SP mode

(Fast)Forward/Fewind: Less than 7 minutes with T-120

Audio Track: 1 track

Audio output: 2 x 2 W

Audio S/N: Better than 35 dB

Video output: 1.0 Vp-p/75 Ohm, unbalanced

Video S/N: Better than 35 dB

Power source: DC 11 V to 16 V

Power consumption: 35 W (Main With Monitor)

Operating temperature: 5~40°C (41~104°F)

Storage temperature: -20~60°C (4~140°F)

Operating humidity: 10~75%

Dimensions (W x H x D): 250 x 263 x 135 mm (9.8" x 10.4" x 5.3")



90 DAY LIMITED WARRANTY

Applies to Audiovox Video Products

AUDIOVOX ELECTRONICS CORP. (the Company) warrants to the original retail purchaser of this product that should this product or any part thereof, under normal use and conditions, be proven defective in material or workmanship within 90 days from the date of original purchase, such defect(s) will be repaired or replaced with reconditioned product (at the Company's option) without charge for parts and repair labor.

To obtain repair or replacement within the terms of this Warranty, the product is to be delivered with proof of warranty coverage (e.g. dated bill of sale), specification of defect(s), transportation prepaid, to the Company at the address shown below.

This Warranty does not extend to the elimination of externally generated static or noise, to correction of antenna problems, to costs incurred for installation, removal or reinstallation of the product, or to damage to tapes, discs, speakers, accessories, or electrical systems.

This Warranty does not apply to any product or part thereof which, in the opinion of the Company, has suffered or been damaged through alteration, improper installation, mishandling, misuse, neglect, accident, or by removal or defacement of the factory serial number/bar code label(s). THE EXTENT OF THE COMPANY'S LIABILITY UNDER THIS WARRANTY IS LIMITED TO THE REPAIR OR REPLACEMENT

PROVIDED ABOVE AND, IN NO EVENT, SHALL THE COMPANY'S LIABILITY EXCEED THE PURCHASE PRICE PAID BY PURCHASER FOR THE PRODUCT.

This Warranty is in lieu of all other express warranties or liabilities. ANY IMPLIED WARRANTIES, INCLUDING ANY IMPLIED WARRANTY OF MERCHANTABILITY, SHALL BE LIMITED TO THE DURATION OF THIS WRITTEN WARRANTY. ANY ACTION FOR BREACH OF ANY WARRANTY HEREUNDER INCLUDING ANY IMPLIED WARRANTY OF MERCHANTABILITY MUST BE BROUGHT WITHIN A PERIOD OF

15 MONTHS FROM DATE OF ORIGINAL PURCHASE. IN NO CASE SHALL THE COMPANY BE LIABLE FOR ANY CONSEQUENTIAL OR INCIDENTAL DAMAGES FOR BREACH OF THIS OR ANY OTHER WARRANTY, EXPRESS OR IMPLIED, WHATSOEVER. No person or representative is authorized to assume for the Company any liability other than expressed herein in connection with the sale of this product.

Some states do not allow limitations on how long an implied warranty lasts or the exclusion or limitation of incidental or consequential damage so the above limitations or exclusions may not apply to you. This Warranty gives you specific legal rights and you may also have other rights which vary from state to state.

U.S.A. : AUDIOVOX ELECTRONICS CORPORATION, 150 MARCUS BLVD.,
HAUPPAUGE, NEW YORK 11788 1-800-645-4994

CANADA : CALL 1-800-645-4994 FOR LOCATION OF WARRANTY STATION
SERVING YOUR AREA

128-5556C



For Customer Service
Visit Our Website At
www.audiovox.com
Product Information, Photos,
FAQ's Owner's Manuals

© 2003 Audiovox Electronics Corp., 150 Marcus Blvd., Hauppauge, N.Y. 11788

128-6647